

16-BIT, 1.25-MSPS, UNIPOLAR PSEUDO-DIFFERENTIAL INPUT, MICROPOWER SAMPLING ANALOG-TO-DIGITAL CONVERTER WITH PARALLEL INTERFACE

FEATURES

- Unipolar Pseudo-Differential Input, 0 V to V_{ref}
- 16-Bit NMC at 1.25 MSPS
- ± 2 LSB INL Max, $-1/+1.5$ LSB DNL
- 86 dB SNR, -90 dB THD at 100 kHz Input
- Zero Latency
- Internal 4.096-V Reference
- High-Speed Parallel Interface
- Single 5-V Analog Supply
- Wide I/O Supply: 2.7 V to 5.25 V
- Low Power: 155 mW at 1.25 MHz Typ
- Pin Compatible With ADS8411/8401
- 48-Pin TQFP Package

APPLICATIONS

- DWDM
- Instrumentation
- High-Speed, High-Resolution, Zero Latency Data Acquisition Systems
- Transducer Interface
- Medical Instruments
- Communications

DESCRIPTION

The ADS8405 is a 16-bit, 1.25-MHz A/D converter with an internal 4.096-V reference. The device includes a 16-bit capacitor-based SAR A/D converter with inherent sample and hold. The ADS8405 offers a full 16-bit interface and an 8-bit option where data is read using two 8-bit read cycles if necessary.

The ADS8405 has a unipolar pseudo-differential input. It is available in a 48-lead TQFP package and is characterized over the industrial -40°C to 85°C temperature range.

High Speed SAR Converter Family

| Type/Speed | 500 kHz | ~600 kHz | 750 kHz | 1 MHz | 1.25 MHz | 2 MHz | 3 MHz | 4 MHz |
|-----------------------------------|---------|-------------|---------|---------|-------------|---------|---------|---------|
| 18-Bit Pseudo-Diff | ADS8383 | ADS8381 | | | | | | |
| | | ADS8380 (S) | | | | | | |
| 18-Bit Pseudo-Bipolar, Fully Diff | | ADS8382 (S) | | | | | | |
| 16-Bit Pseudo-Diff | | | ADS8371 | | ADS8401/05 | ADS8411 | | |
| 16-Bit Pseudo-Bipolar, Fully Diff | | | | | ADS8402/06 | ADS8412 | | |
| 14-Bit Pseudo-Diff | | | | | ADS7890 (S) | | ADS7891 | |
| 12-Bit Pseudo-Diff | | | | ADS7886 | | | | ADS7881 |

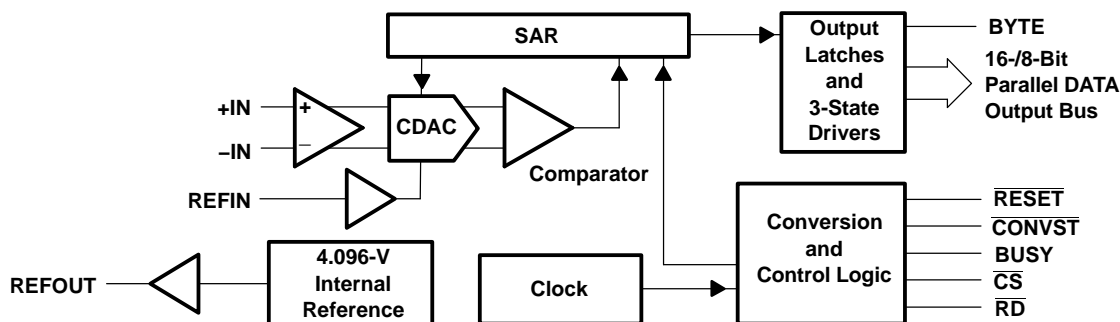

Please be aware that an important notice concerning availability, standard warranty, and use in critical applications of Texas Instruments semiconductor products and disclaimers thereto appears at the end of this data sheet.

ORDERING INFORMATION⁽¹⁾

| MODEL | MAXIMUM INTEGRAL LINEARITY (LSB) | MAXIMUM DIFFERENTIAL LINEARITY (LSB) | NO MISSING CODES RESOLUTION (BIT) | PACKAGE TYPE | PACKAGE DESIGNATOR | TEMPERATURE RANGE | ORDERING INFORMATION | TRANSPORT MEDIA QUANTITY |
|-----------|----------------------------------|--------------------------------------|-----------------------------------|--------------|--------------------|-------------------|----------------------|--------------------------|
| ADS8405I | -4 to +4 | -2 to +2 | 15 | 48 Pin TQFP | PFB | -40°C to 85°C | ADS8405IPFBT | Tape and reel 250 |
| | | | | | | | ADS8405IPFBR | Tape and reel 1000 |
| ADS8405IB | -2 to +2 | -1 to +1.5 | 16 | 48 Pin TQFP | PFB | -40°C to 85°C | ADS8405IBPFBT | Tape and reel 250 |
| | | | | | | | ADS8405IBPFBR | Tape and reel 1000 |

(1) For the most current specifications and package information, refer to our website at www.ti.com.

ABSOLUTE MAXIMUM RATINGS

over operating free-air temperature range unless otherwise noted⁽¹⁾

| | | UNIT |
|---|--------------------------------------|--|
| Voltage | +IN to AGND | -0.4 V to +VA + 0.1 V |
| | -IN to AGND | -0.4 V to 0.5 V |
| | +VA to AGND | -0.3 V to 7 V |
| | +VBD to BDGND | -0.3 V to 7 V |
| | +VA to +VBD | -0.3 V to 2.55 V |
| Digital input voltage to BDGND | | -0.3 V to +VBD + 0.3 V |
| Digital output voltage to BDGND | | -0.3 V to +VBD + 0.3 V |
| T _A | Operating free-air temperature range | -40°C to 85°C |
| T _{stg} | Storage temperature range | -65°C to 150°C |
| Junction temperature (T _J max) | | 150°C |
| TQFP package | Power dissipation | (T _J Max - T _A)/θ _{JA} |
| | θ _{JA} thermal impedance | 86°C/W |
| Lead temperature, soldering | Vapor phase (60 sec) | 215°C |
| | Infrared (15 sec) | 220°C |

(1) Stresses beyond those listed under *absolute maximum ratings* may cause permanent damage to the device. These are stress ratings only, and functional operation of the device at these or any other conditions beyond those indicated under *recommended operating conditions* is not implied. Exposure to absolute-maximum-rated conditions for extended periods may affect device reliability.

SPECIFICATIONS
 $T_A = -40^{\circ}\text{C}$ to 85°C , $+V_A = 5\text{ V}$, $+V_{BD} = 3\text{ V}$ or 5 V , $V_{ref} = 4.096\text{ V}$, $f_{SAMPLE} = 1.25\text{ MHz}$ (unless otherwise noted)

| PARAMETER | | TEST CONDITIONS | MIN | TYP | MAX | UNIT |
|---|--|---|--------|------------|-----------------|-------------------|
| ANALOG INPUT | | | | | | |
| Full-scale input voltage ⁽¹⁾ | | +IN – (–IN) | 0 | | V_{ref} | V |
| Absolute input voltage | | +IN | –0.2 | | $V_{ref} + 0.2$ | V |
| | | –IN | –0.2 | | 0.2 | |
| Input capacitance | | | | 25 | | pF |
| Input leakage current | | | | 0.5 | | nA |
| SYSTEM PERFORMANCE | | | | | | |
| Resolution | | | | 16 | | Bits |
| No missing codes | | ADS8405I | 15 | | | Bits |
| | | ADS8405IB | 16 | | | |
| INL | Integral linearity ⁽²⁾⁽³⁾ | ADS8405I | –4 | ± 2 | 4 | LSB |
| | | ADS8405IB | –2 | ± 1 | 2 | |
| DNL | Differential linearity | ADS8405I | –2 | ± 1 | 2 | LSB |
| | | ADS8405IB | –1 | ± 0.75 | 1.5 | |
| E_O | Offset error ⁽⁴⁾ | ADS8405I | –3 | ± 1 | 3 | mV |
| | | ADS8405IB | –1.5 | ± 0.5 | 1.5 | mV |
| E_G | Gain error ⁽⁴⁾⁽⁵⁾ | ADS8405I | –0.15 | | 0.15 | %FS |
| | | ADS8405IB | –0.098 | | 0.98 | |
| Noise | | | | 60 | | $\mu\text{V RMS}$ |
| DC Power supply rejection ratio | | At FFFFh output code, $+V_A = 4.75\text{ V}$ to 5.25 V , $V_{ref} = 4.096\text{ V}$ ⁽⁴⁾ | | 2 | | LSB |
| SAMPLING DYNAMICS | | | | | | |
| Conversion time | | | 500 | | 650 | ns |
| Acquisition time | | | 150 | | | ns |
| Throughput rate | | | | | 1.25 | MHz |
| Aperture delay | | | | 2 | | ns |
| Aperture jitter | | | | 25 | | ps |
| Step response | | | | 100 | | ns |
| Overvoltage recovery | | | | 100 | | ns |
| DYNAMIC CHARACTERISTICS | | | | | | |
| THD | Total harmonic distortion ⁽⁶⁾ | $V_{IN} = 4 V_{p-p}$ at 100 kHz | –90 | | | dB |
| | | $V_{IN} = 4 V_{p-p}$ at 500 kHz | –88.5 | | | |
| SNR | Signal-to-noise ratio | $V_{IN} = 4 V_{p-p}$ at 100 kHz | 86 | | | dB |
| SINAD | Signal-to-noise + distortion | $V_{IN} = 4 V_{p-p}$ at 100 kHz | 85 | | | dB |
| SFDR | Spurious free dynamic range | $V_{IN} = 4 V_{p-p}$ at 100 kHz | 90 | | | dB |
| | | $V_{IN} = 4 V_{p-p}$ at 500 kHz | 88 | | | |
| –3dB Small signal bandwidth | | | 5 | | | MHz |
| EXTERNAL VOLTAGE REFERENCE INPUT | | | | | | |
| Reference voltage at REFIN, V_{ref} | | | 2.5 | 4.096 | 4.2 | V |
| Reference resistance ⁽⁷⁾ | | | 500 | | | k Ω |

(1) Ideal input span, does not include gain or offset error.

(2) LSB means least significant bit

(3) This is endpoint INL, not best fit.

(4) Measured relative to an ideal full-scale input (+IN – (–IN)) of 4.096 V.

(5) This specification does not include the internal reference voltage error and drift.

(6) Calculated on the first nine harmonics of the input frequency.

 (7) Can vary $\pm 20\%$

SPECIFICATIONS (continued)

$T_A = -40^{\circ}\text{C}$ to 85°C , $+VA = 5\text{ V}$, $+VBD = 3\text{ V}$ or 5 V , $V_{\text{ref}} = 4.096\text{ V}$, $f_{\text{SAMPLE}} = 1.25\text{ MHz}$ (unless otherwise noted)

| PARAMETER | | TEST CONDITIONS | MIN | TYP | MAX | UNIT |
|-----------------------------------|---------------------------|---|--------------|-------|--------------|--------------------|
| INTERNAL REFERENCE OUTPUT | | | | | | |
| Internal reference start-up time | | From 95% (+VA), with 1- μF storage capacitor | | | 120 | ms |
| V_{ref} range | | $I_{\text{OUT}} = 0$ | 4.065 | 4.096 | 4.13 | V |
| Source current | | Static load | | | 10 | μA |
| Line regulation | | $+VA = 4.75\text{ V}$ to 5.25 V | | 0.6 | | mV |
| Drift | | $I_{\text{OUT}} = 0$ | | 36 | | PPM/C |
| DIGITAL INPUT/OUTPUT | | | | | | |
| Logic family - CMOS | | | | | | |
| V_{IH} | High-level input voltage | $I_{\text{IH}} = 5\ \mu\text{A}$ | $+VBD - 1$ | | $+VBD + 0.3$ | V |
| V_{IL} | Low-level input voltage | $I_{\text{IL}} = 5\ \mu\text{A}$ | -0.3 | | 0.8 | |
| V_{OH} | High-level output voltage | $I_{\text{OH}} = 2\text{ TTL loads}$ | $+VBD - 0.6$ | | $+VBD$ | |
| V_{OL} | Low-level output voltage | $I_{\text{OL}} = 2\text{ TTL loads}$ | 0 | | 0.4 | |
| Data format - straight binary | | | | | | |
| POWER SUPPLY REQUIREMENTS | | | | | | |
| Power supply voltage | | +VBD | 2.7 | 3 | 5.25 | V |
| | | +VA | 4.75 | 5 | 5.25 | V |
| +VA Supply current ⁽⁸⁾ | | $f_s = 1.25\text{ MHz}$ | | 31 | 34 | mA |
| Power dissipation ⁽⁸⁾ | | $f_s = 1.25\text{ MHz}$ | | 155 | 170 | mW |
| TEMPERATURE RANGE | | | | | | |
| Operating free-air | | | -40 | | 85 | $^{\circ}\text{C}$ |

(8) This includes only VA+ current. +VBD current is typically 1 mA with 5-pF load capacitance on output pins.

TIMING CHARACTERISTICS

All specifications typical at -40°C to 85°C , $+V_A = +V_{BD} = 5\text{ V}$ ⁽¹⁾⁽²⁾⁽³⁾

| PARAMETER | | MIN | TYP | MAX | UNIT |
|---------------------|---|---|-----|-----|------|
| t_{CONV} | Conversion time | 500 | | 650 | ns |
| t_{ACQ} | Acquisition time | 150 | | | ns |
| t_{pd1} | $\overline{\text{CONVST}}$ low to BUSY high | | 40 | | ns |
| t_{pd2} | Propagation delay time, end of conversion to BUSY low | | 5 | | ns |
| t_{w1} | Pulse duration, $\overline{\text{CONVST}}$ low | 20 | | | ns |
| t_{su1} | Setup time, $\overline{\text{CS}}$ low to $\overline{\text{CONVST}}$ low | 0 | | | ns |
| t_{w2} | Pulse duration, $\overline{\text{CONVST}}$ high | 20 | | | ns |
| | $\overline{\text{CONVST}}$ falling edge jitter | | | 10 | ps |
| t_{w3} | Pulse duration, BUSY signal low | Min(t_{ACQ}) | | | ns |
| t_{w4} | Pulse duration, BUSY signal high | | 610 | | ns |
| t_{h1} | Hold time, first data bus data transition ($\overline{\text{RD}}$ low, or $\overline{\text{CS}}$ low for read cycle, or BYTE input changes) after $\overline{\text{CONVST}}$ low | 40 | | | ns |
| t_{d1} | Delay time, $\overline{\text{CS}}$ low to $\overline{\text{RD}}$ low (or BUSY low to $\overline{\text{RD}}$ low when $\overline{\text{CS}} = 0$) | 0 | | | ns |
| t_{su2} | Setup time, $\overline{\text{RD}}$ high to $\overline{\text{CS}}$ high | 0 | | | ns |
| t_{w5} | Pulse duration, $\overline{\text{RD}}$ low | 50 | | | ns |
| t_{en} | Enable time, $\overline{\text{RD}}$ low (or $\overline{\text{CS}}$ low for read cycle) to data valid | | | 20 | ns |
| t_{d2} | Delay time, data hold from $\overline{\text{RD}}$ high | 0 | | | ns |
| t_{d3} | Delay time, BYTE rising edge or falling edge to data valid | 2 | | 20 | ns |
| t_{w6} | Pulse duration, $\overline{\text{RD}}$ high | 20 | | | ns |
| t_{w7} | Pulse duration, $\overline{\text{CS}}$ high | 20 | | | ns |
| t_{h2} | Hold time, last $\overline{\text{RD}}$ (or $\overline{\text{CS}}$ for read cycle) rising edge to $\overline{\text{CONVST}}$ falling edge | 50 | | | ns |
| t_{su3} | Setup time, BYTE transition to $\overline{\text{RD}}$ falling edge | 0 | | | ns |
| t_{h3} | Hold time, BYTE transition to $\overline{\text{RD}}$ falling edge | 0 | | | ns |
| t_{dis} | Disable time, $\overline{\text{RD}}$ high ($\overline{\text{CS}}$ high for read cycle) to 3-stated data bus | | | 20 | ns |
| t_{d5} | Delay time, end of conversion to MSB data valid | | | 10 | ns |
| t_{su4} | Byte transition setup time, from BYTE transition to next BYTE transition | 50 | | | ns |
| t_{d6} | Delay time, $\overline{\text{CS}}$ rising edge to BUSY falling edge | 50 | | | ns |
| t_{d7} | Delay time, BUSY falling edge to $\overline{\text{CS}}$ rising edge | 50 | | | ns |
| $t_{\text{su(AB)}}$ | Setup time, from the falling edge of $\overline{\text{CONVST}}$ (used to start the valid conversion) to the next falling edge of $\overline{\text{CONVST}}$ (when $\overline{\text{CS}} = 0$ and $\overline{\text{CONVST}}$ used to abort) or to the next falling edge of $\overline{\text{CS}}$ (when $\overline{\text{CS}}$ is used to abort) | 60 | | 500 | ns |
| t_{su5} | Setup time, falling edge of $\overline{\text{CONVST}}$ to read valid data (MSB) from current conversion | MAX(t_{CONV}) + MAX(t_{d5}) | | | ns |
| t_{h4} | Hold time, data (MSB) from previous conversion hold valid from falling edge of $\overline{\text{CONVST}}$ | MIN(t_{CONV}) | | | ns |

- (1) All input signals are specified with $t_r = t_f = 5\text{ ns}$ (10% to 90% of $+V_{BD}$) and timed from a voltage level of $(V_{IL} + V_{IH})/2$.
- (2) See timing diagrams.
- (3) All timings are measured with 20-pF equivalent loads on all data bits and BUSY pins.

TIMING CHARACTERISTICS

All specifications typical at –40°C to 85°C, +VA = 5 V, +VBD = 3 V⁽¹⁾⁽²⁾⁽³⁾

| PARAMETER | | MIN | TYP | MAX | UNIT |
|---------------------|---|---|-----|-----|------|
| t _{CONV} | Conversion time | 500 | | 650 | ns |
| t _{ACQ} | Acquisition time | 150 | | | ns |
| t _{pd1} | $\overline{\text{CONVST}}$ low to BUSY high | | 50 | | ns |
| t _{pd2} | Propagation delay time, end of conversion to BUSY low | | 10 | | ns |
| t _{w1} | Pulse duration, $\overline{\text{CONVST}}$ low | 20 | | | ns |
| t _{su1} | Setup time, $\overline{\text{CS}}$ low to $\overline{\text{CONVST}}$ low | 0 | | | ns |
| t _{w2} | Pulse duration, $\overline{\text{CONVST}}$ high | 20 | | | ns |
| | $\overline{\text{CONVST}}$ falling edge jitter | | | 10 | ps |
| t _{w3} | Pulse duration, BUSY signal low | Min(t _{ACQ}) | | | ns |
| t _{w4} | Pulse duration, BUSY signal high | | 610 | | ns |
| t _{h1} | Hold time, first data bus transition ($\overline{\text{RD}}$ low, or $\overline{\text{CS}}$ low for read cycle, or BYTE input changes) after $\overline{\text{CONVST}}$ low | 40 | | | ns |
| t _{d1} | Delay time, $\overline{\text{CS}}$ low to $\overline{\text{RD}}$ low (or BUSY low to $\overline{\text{RD}}$ low when $\overline{\text{CS}} = 0$) | 0 | | | ns |
| t _{su2} | Setup time, $\overline{\text{RD}}$ high to $\overline{\text{CS}}$ high | 0 | | | ns |
| t _{w5} | Pulse duration, $\overline{\text{RD}}$ low | 50 | | | ns |
| t _{en} | Enable time, $\overline{\text{RD}}$ low (or $\overline{\text{CS}}$ low for read cycle) to data valid | | | 30 | ns |
| t _{d2} | Delay time, data hold from $\overline{\text{RD}}$ high | 0 | | | ns |
| t _{d3} | Delay time, BYTE rising edge or falling edge to data valid | 2 | | 30 | ns |
| t _{w6} | Pulse duration, $\overline{\text{RD}}$ high | 20 | | | ns |
| t _{w7} | Pulse duration, $\overline{\text{CS}}$ high | 20 | | | ns |
| t _{h2} | Hold time, last $\overline{\text{RD}}$ (or $\overline{\text{CS}}$ for read cycle) rising edge to $\overline{\text{CONVST}}$ falling edge | 50 | | | ns |
| t _{su3} | Setup time, BYTE transition to $\overline{\text{RD}}$ falling edge | 0 | | | ns |
| t _{h3} | Hold time, BYTE transition to $\overline{\text{RD}}$ falling edge | 0 | | | ns |
| t _{dis} | Disable time, $\overline{\text{RD}}$ high ($\overline{\text{CS}}$ high for read cycle) to 3-stated data bus | | | 30 | ns |
| t _{d5} | Delay time, end of conversion to MSB data valid | | | 20 | ns |
| t _{su4} | Byte transition setup time, from BYTE transition to next BYTE transition | 50 | | | ns |
| t _{d6} | Delay time, $\overline{\text{CS}}$ rising edge to BUSY falling edge | 50 | | | ns |
| t _{d7} | Delay time, BUSY falling edge to $\overline{\text{CS}}$ rising edge | 50 | | | ns |
| t _{su(AB)} | Setup time, from the falling edge of $\overline{\text{CONVST}}$ (used to start the valid conversion) to the next falling edge of $\overline{\text{CONVST}}$ (when $\overline{\text{CS}} = 0$ and $\overline{\text{CONVST}}$ used to abort) or to the next falling edge of $\overline{\text{CS}}$ (when $\overline{\text{CS}}$ is used to abort) | 70 | | 500 | ns |
| t _{su5} | Setup time, falling edge of $\overline{\text{CONVST}}$ to read valid data (MSB) from current conversion | MAX(t _{CONV}) + MAX(t _{d5}) | | | ns |
| t _{h4} | Hold time, data (MSB) from previous conversion hold valid from falling edge of $\overline{\text{CONVST}}$ | MIN(t _{CONV}) | | | ns |

- (1) All input signals are specified with t_r = t_f = 5 ns (10% to 90% of +VBD) and timed from a voltage level of (V_{IL} + V_{IH})/2.
- (2) See timing diagrams.
- (3) All timings are measured with 10-pF equivalent loads on all data bits and BUSY pins.

PIN ASSIGNMENTS

**PFB PACKAGE
(TOP VIEW)**

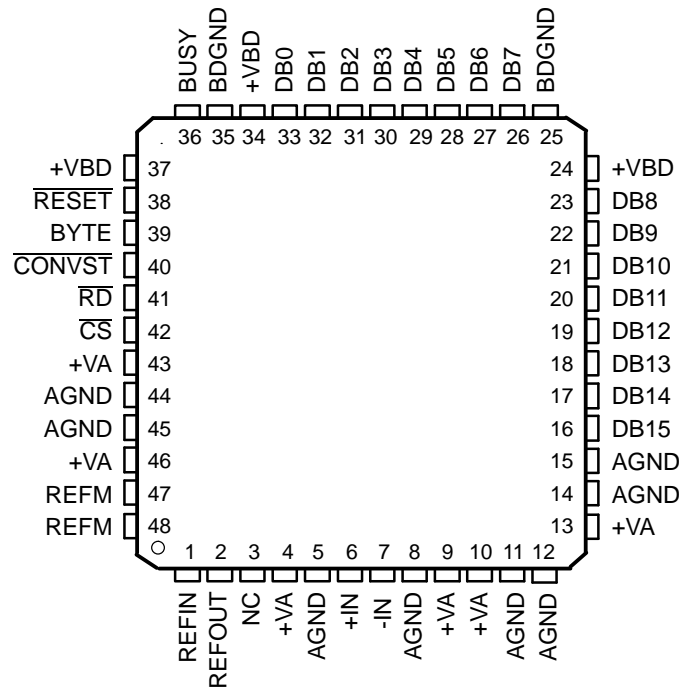

NC - No connection

Terminal Functions

| NAME | NO. | I/O | DESCRIPTION | | |
|----------------------------|------------------------------|-----|---|-----------------|-------------------|
| AGND | 5, 8, 11, 12, 14, 15, 44, 45 | – | Analog ground | | |
| BDGND | 25, 35 | – | Digital ground for bus interface digital supply | | |
| BUSY | 36 | O | Status output. High when a conversion is in progress. | | |
| BYTE | 39 | I | Byte select input. Used for 8-bit bus reading. 0: No fold back 1: Low byte D[7:0] of the 16 most significant bits is folded back to high byte of the 16 most significant pins DB[15:8]. | | |
| $\overline{\text{CONVST}}$ | 40 | I | Convert start. The falling edge of this input ends the acquisition period and starts the hold period. | | |
| $\overline{\text{CS}}$ | 42 | I | Chip select. The falling edge of this input starts the acquisition period. | | |
| Data Bus | | | 8-Bit Bus | | 16-Bit Bus |
| | | | BYTE = 0 | BYTE = 1 | BYTE = 0 |
| DB15 | 16 | O | D15 (MSB) | D7 | D15 (MSB) |
| DB14 | 17 | O | D14 | D6 | D14 |
| DB13 | 18 | O | D13 | D5 | D13 |
| DB12 | 19 | O | D12 | D4 | D12 |
| DB11 | 20 | O | D11 | D3 | D11 |
| DB10 | 21 | O | D10 | D2 | D10 |
| DB9 | 22 | O | D9 | D1 | D9 |
| DB8 | 23 | O | D8 | D0 (LSB) | D8 |
| DB7 | 26 | O | D7 | All ones | D7 |
| DB6 | 27 | O | D6 | All ones | D6 |
| DB5 | 28 | O | D5 | All ones | D5 |
| DB4 | 29 | O | D4 | All ones | D4 |
| DB3 | 30 | O | D3 | All ones | D3 |
| DB2 | 31 | O | D2 | All ones | D2 |
| DB1 | 32 | O | D1 | All ones | D1 |
| DB0 | 33 | O | D0 (LSB) | All ones | D0 (LSB) |
| –IN | 7 | I | Inverting input channel | | |
| +IN | 6 | I | Noninverting input channel | | |
| NC | 3 | – | No connection | | |
| REFIN | 1 | I | Reference input | | |
| REFM | 47, 48 | I | Reference ground | | |
| REFOUT | 2 | O | Reference output. Add 1- μ F capacitor between the REFOUT pin and REFM pin when the internal reference is used. | | |
| $\overline{\text{RESET}}$ | 38 | I | Current conversion is aborted and output latches are cleared (set to zeros) when this pin is asserted low. $\overline{\text{RESET}}$ works independantly of $\overline{\text{CS}}$. | | |
| $\overline{\text{RD}}$ | 41 | I | Synchronization pulse for the parallel output. When $\overline{\text{CS}}$ is low, this serves as the output enable and puts the previous conversion result on the bus. | | |
| +VA | 4, 9, 10, 13, 43, 46 | – | Analog power supplies, 5-V dc | | |
| +VBD | 24, 34, 37 | – | Digital power supply for bus | | |

TIMING DIAGRAMS

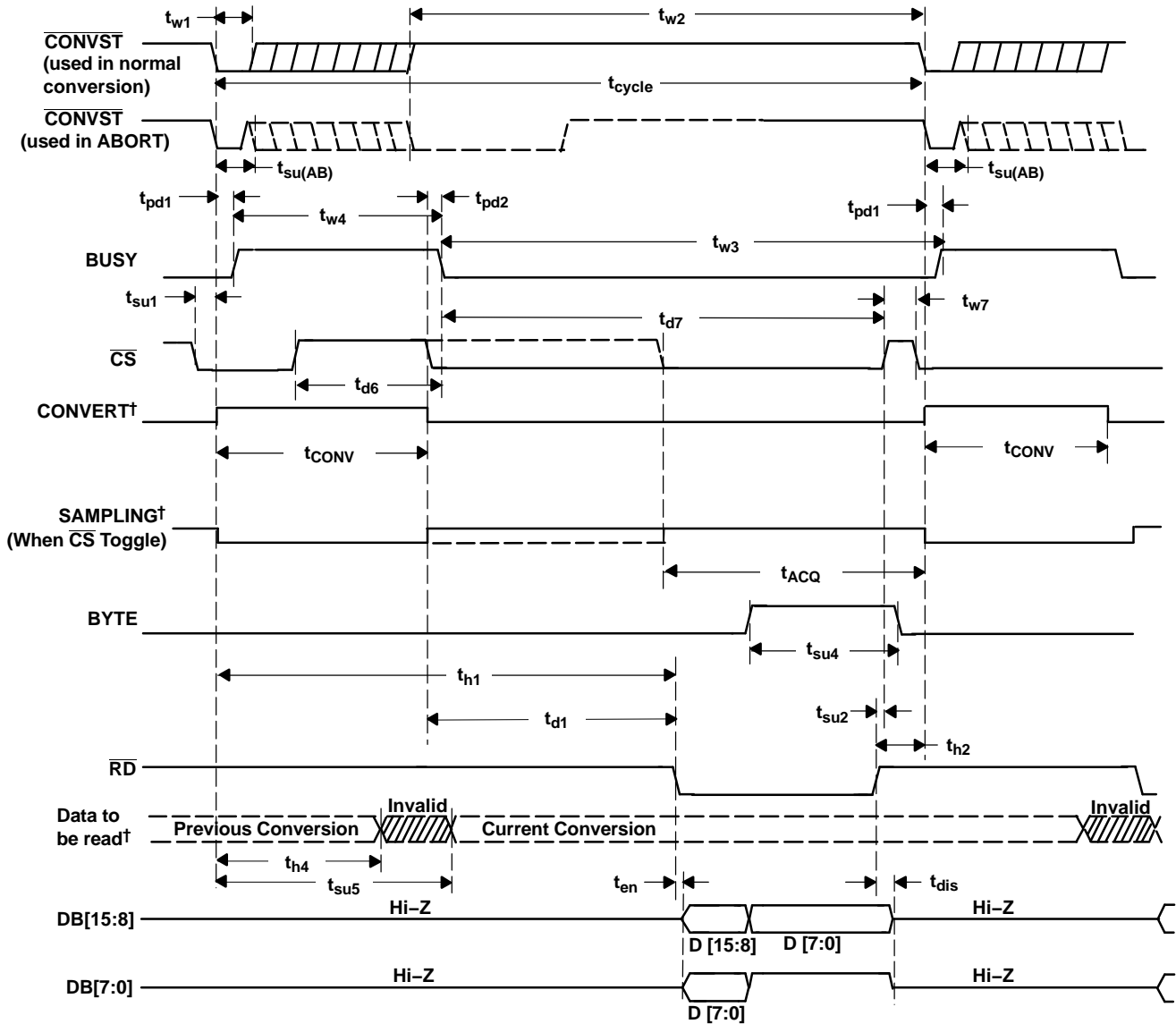

†Signal internal to device

Figure 1. Timing for Conversion and Acquisition Cycles With $\overline{\text{CS}}$ and $\overline{\text{RD}}$ Toggling

TIMING DIAGRAMS (continued)

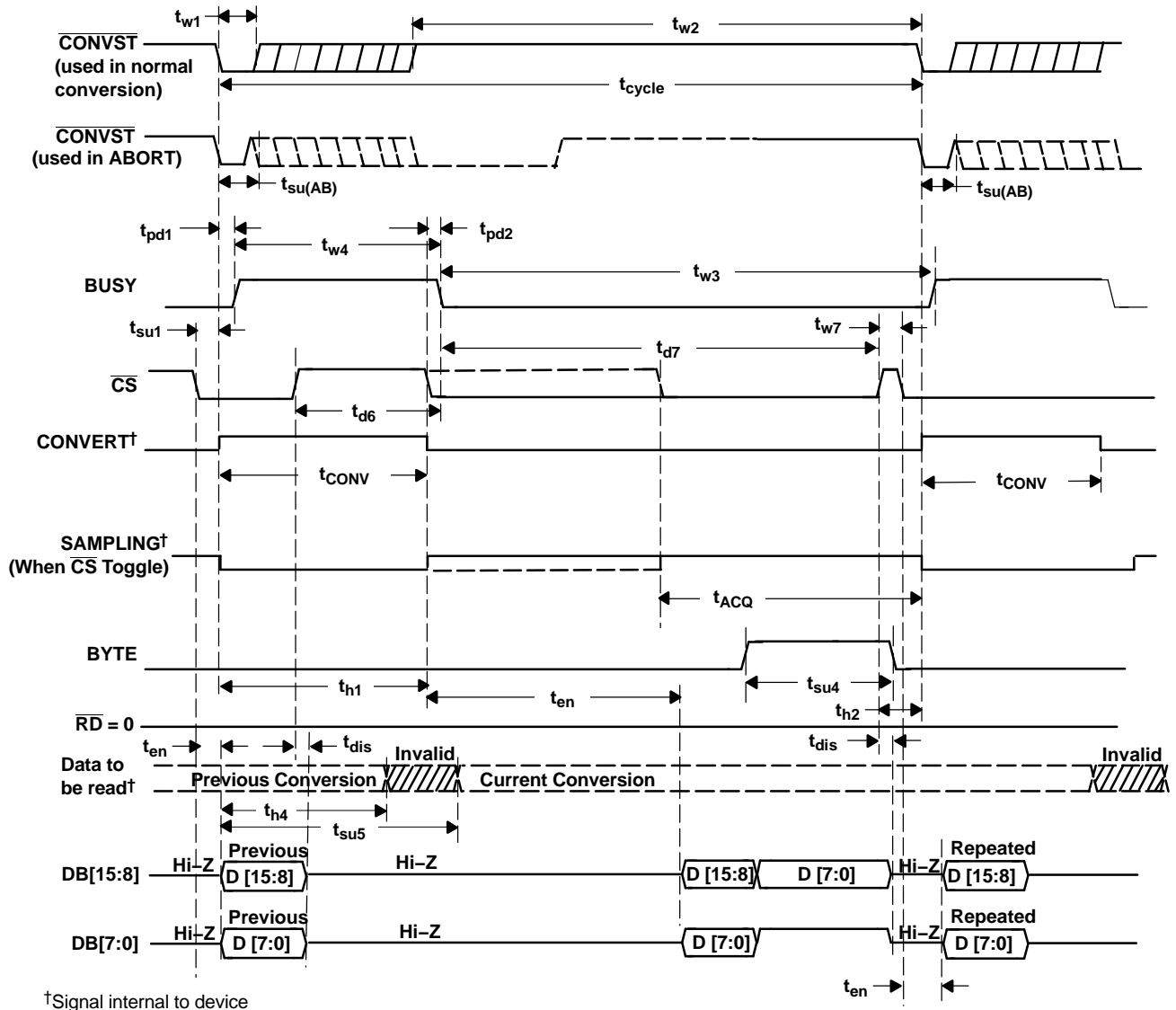
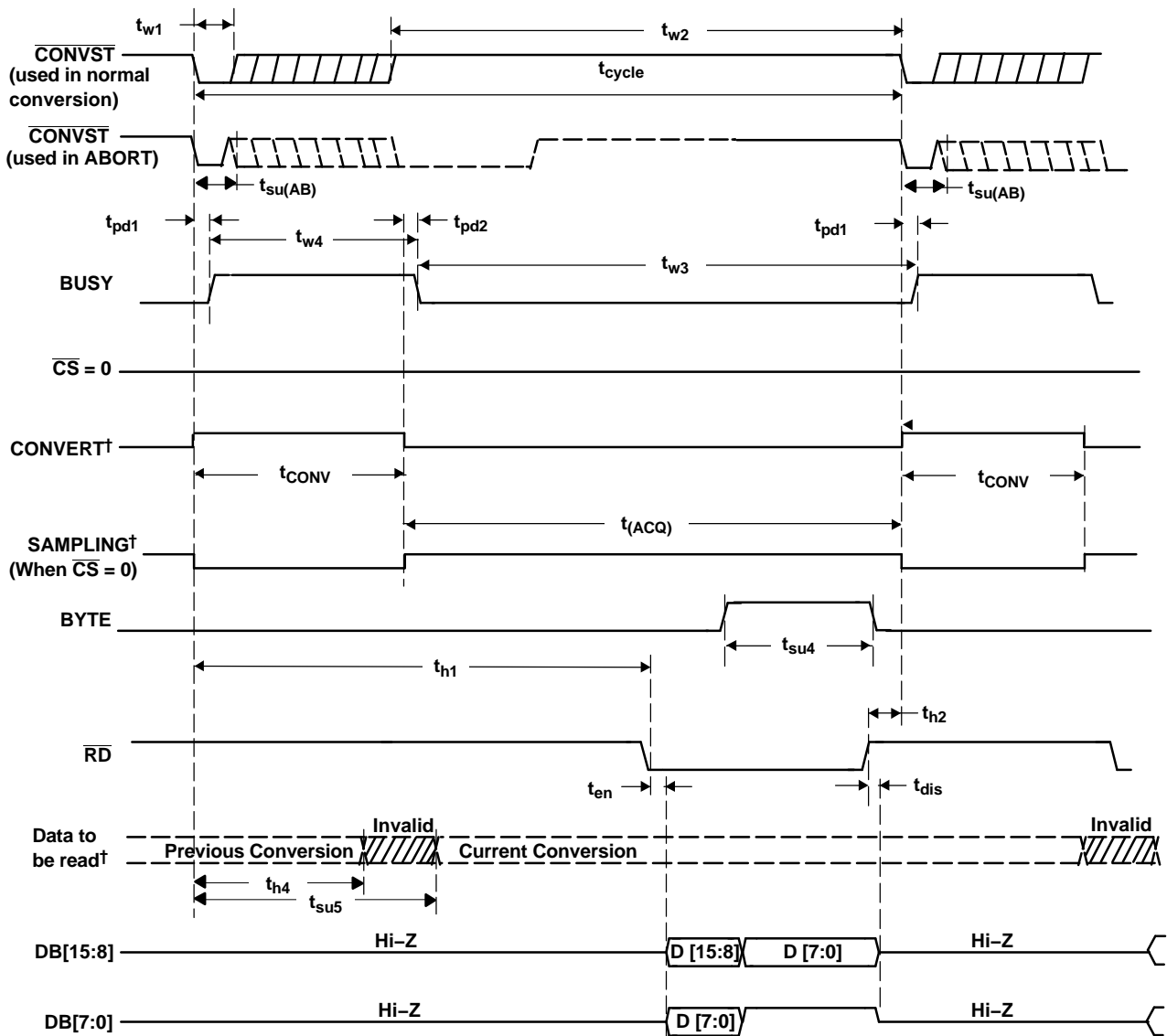

Figure 2. Timing for Conversion and Acquisition Cycles With \overline{CS} Toggling, \overline{RD} Tied to BDGND

TIMING DIAGRAMS (continued)



†Signal internal to device

Figure 3. Timing for Conversion and Acquisition Cycles With \overline{CS} Tied to BDGND, \overline{RD} Toggling

TIMING DIAGRAMS (continued)

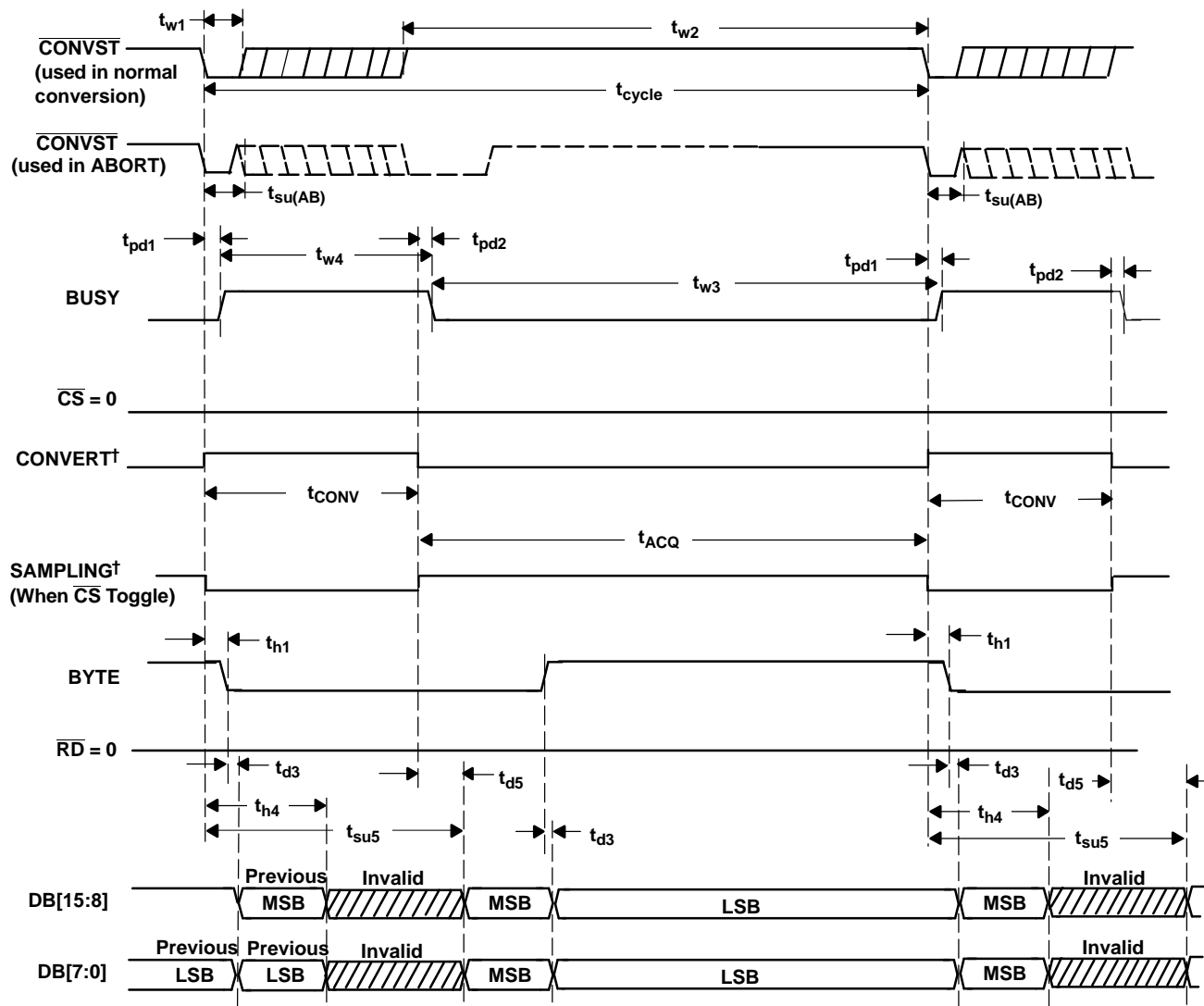

†Signal internal to device

Figure 4. Timing for Conversion and Acquisition Cycles With \overline{CS} and \overline{RD} Tied to BDGND—Auto Read

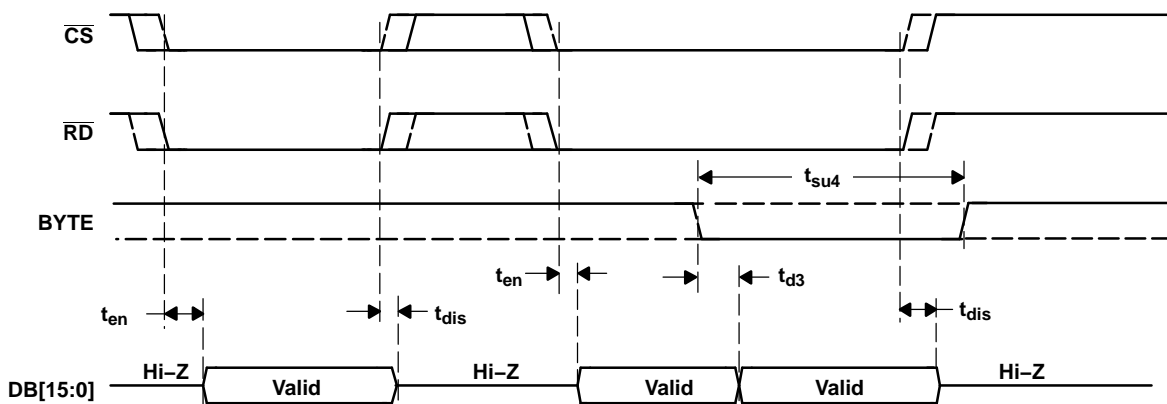

Figure 5. Detailed Timing for Read Cycles

TYPICAL CHARACTERISTICS

At -40°C to 85°C , $+V_A = 5\text{ V}$, $+V_{BD} = 5\text{ V}$, $\text{REFIN} = 4.096\text{ V}$ (internal reference used) and $f_{\text{sample}} = 1.25\text{ MHz}$ (unless otherwise noted)

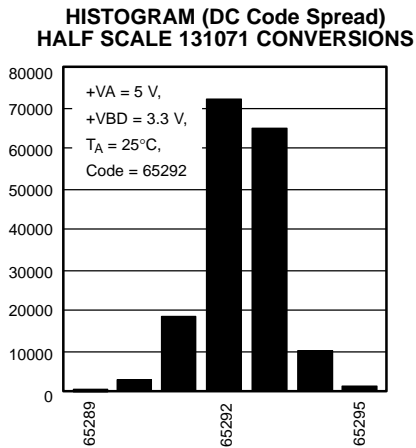

Figure 6.

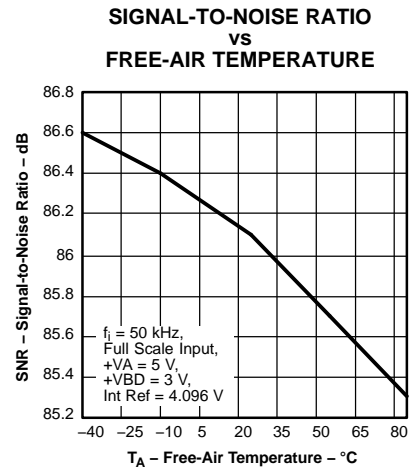

Figure 7.

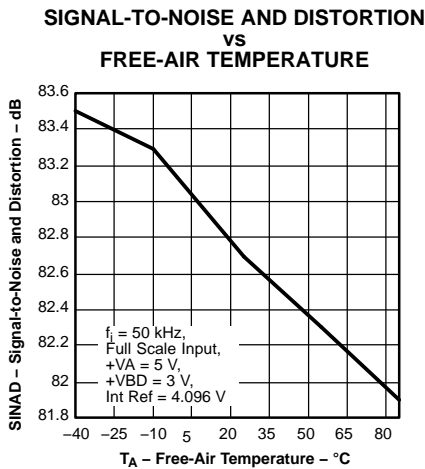

Figure 8.

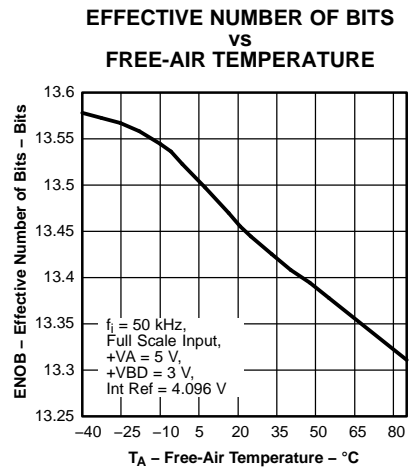
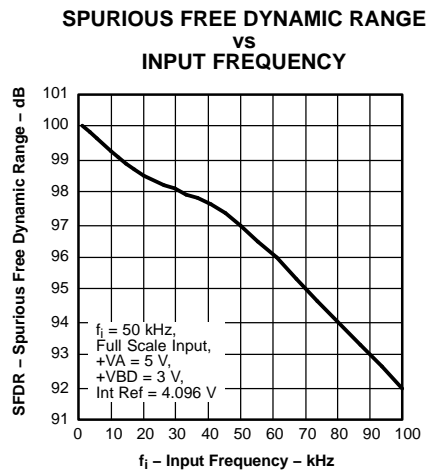
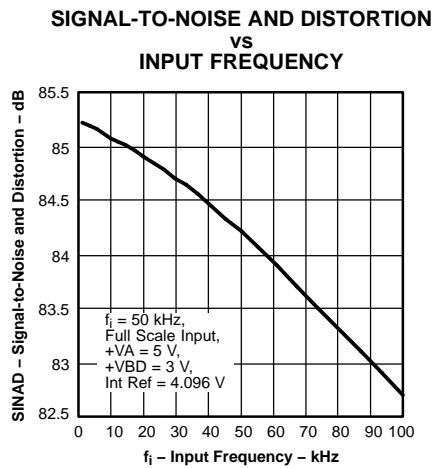
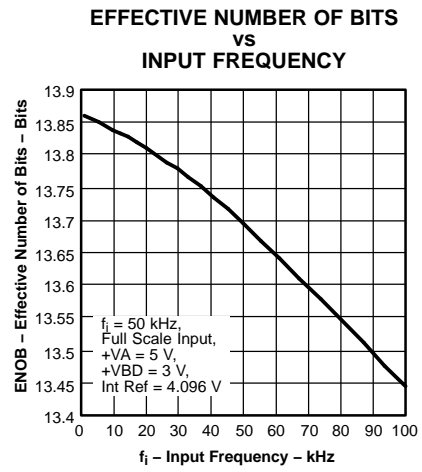
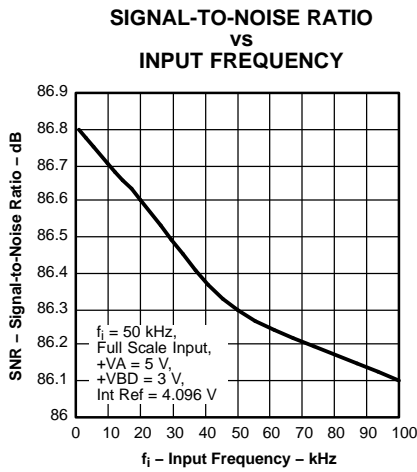
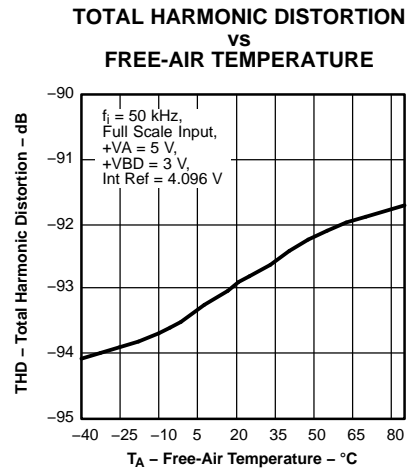
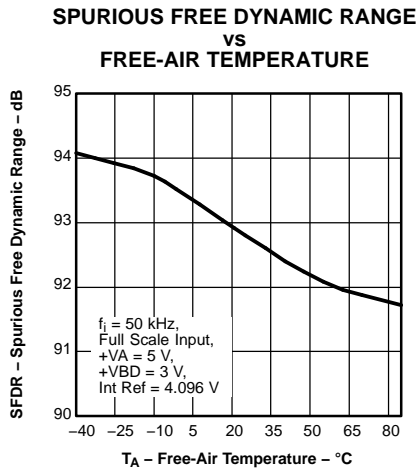

Figure 9.

TYPICAL CHARACTERISTICS (continued)



TYPICAL CHARACTERISTICS (continued)

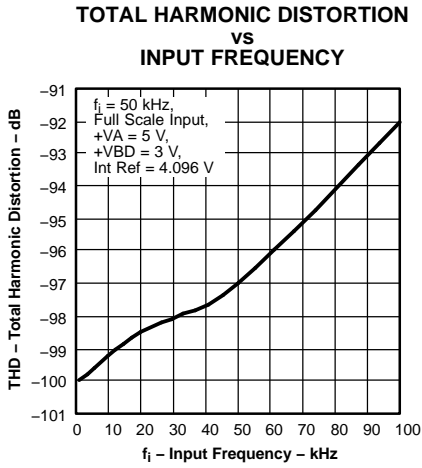

Figure 16.

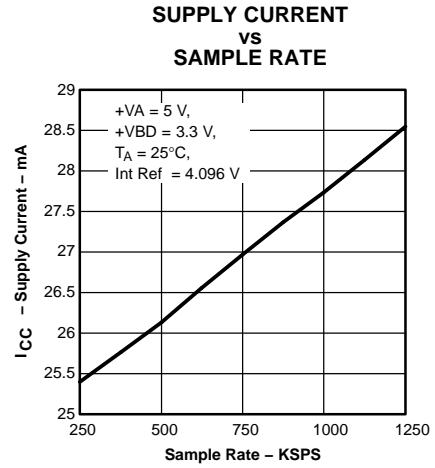

Figure 17.

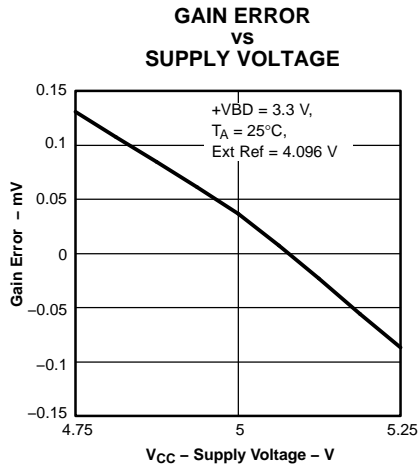

Figure 18.

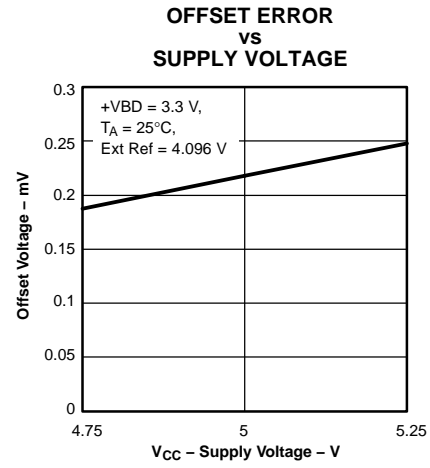

Figure 19.

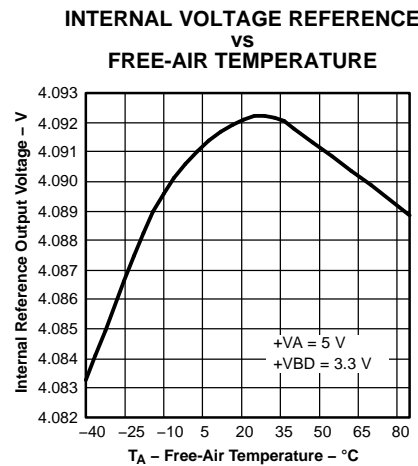

Figure 20.

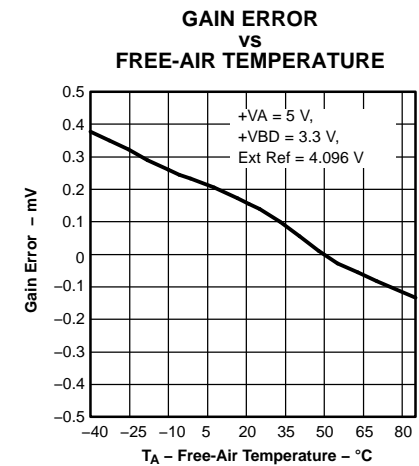

Figure 21.

TYPICAL CHARACTERISTICS (continued)

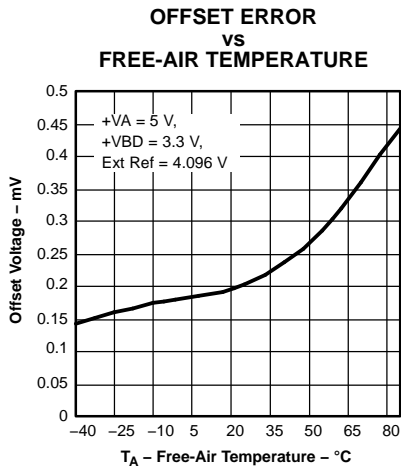

Figure 22.

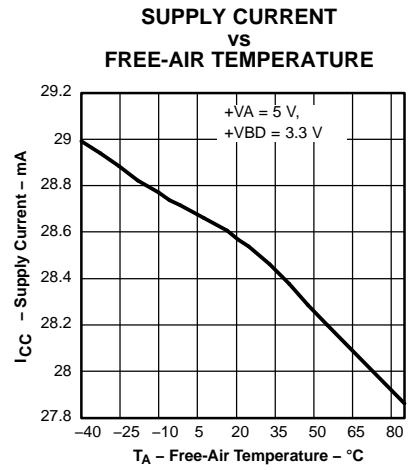

Figure 23.

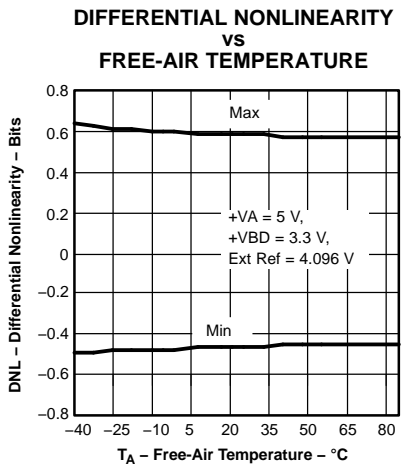

Figure 24.

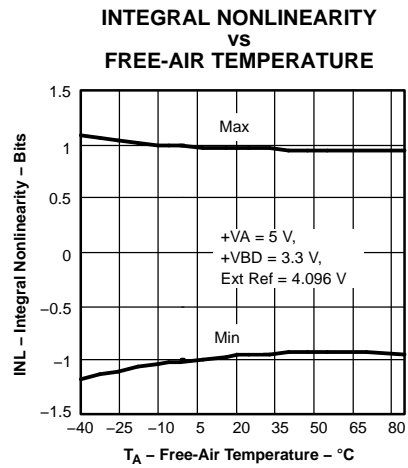

Figure 25.

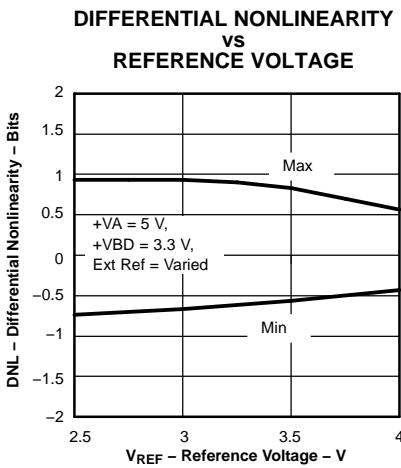

Figure 26.

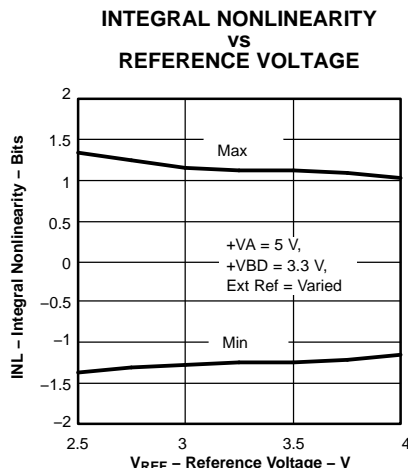

Figure 27.

TYPICAL CHARACTERISTICS (continued)

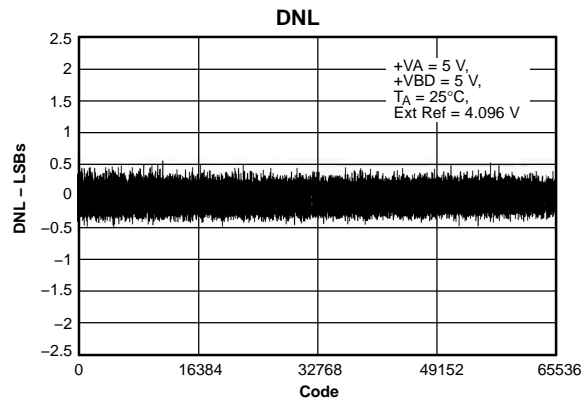

Figure 28.

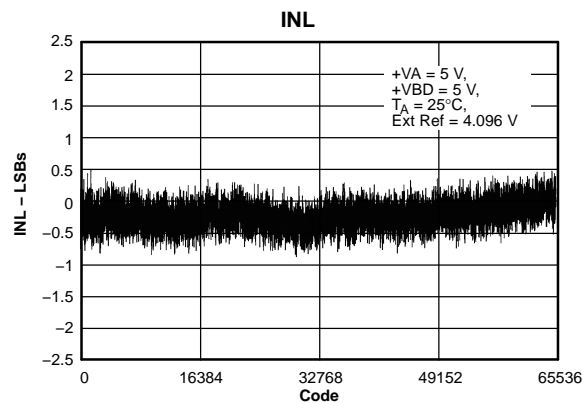

Figure 29.

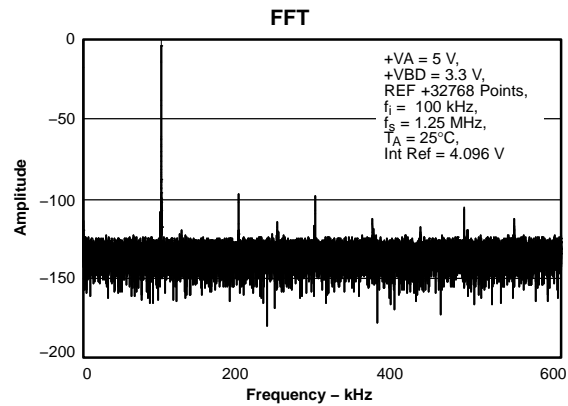

Figure 30.

PRINCIPLES OF OPERATION (continued)

The analog input is provided to two input pins: +IN and –IN. When a conversion is initiated, the differential input on these pins is sampled on the internal capacitor array. While a conversion is in progress, both inputs are disconnected from any internal function.

REFERENCE

The ADS8405 can operate with an external reference with a range from 2.5 V to 4.2 V. A 4.096-V internal reference is included. When an internal reference is used, pin 2 (REFOUT) should be connected to pin 1 (REFIN) with a 0.1- μF decoupling capacitor and a 1- μF storage capacitor between pin 2 (REFOUT) and pins 47 and 48 (REFM) (see Figure 32). The internal reference of the converter is double buffered. If an external reference is used, the second buffer provides isolation between the external reference and the CDAC. This buffer is also used to recharge all of the capacitors of the CDAC during conversion. Pin 2 (REFOUT) can be left unconnected (floating) if an external reference is used.

ANALOG INPUT

When the converter enters hold mode, the voltage difference between the +IN and –IN inputs is captured on the internal capacitor array. The voltage on the –IN input is limited between -0.2 V and 0.2 V , allowing the input to reject small signals which are common to both the +IN and –IN inputs. The +IN input has a range of -0.2 V to $V_{\text{ref}} + 0.2\text{ V}$. The input span ($+IN - (-IN)$) is limited to 0 V to V_{ref} .

The input current on the analog inputs depends upon a number of factors: sample rate, input voltage, and source impedance. Essentially, the current into the ADS8405 charges the internal capacitor array during the sample period. After this capacitance has been fully charged, there is no further input current. The source of the analog input voltage must be able to charge the input capacitance (25 pF) to an 16-bit settling level within the acquisition time (150 ns) of the device. When the converter goes into hold mode, the input impedance is greater than $1\text{ G}\Omega$.

Care must be taken regarding the absolute analog input voltage. To maintain the linearity of the converter, the +IN and –IN inputs and the span ($+IN - (-IN)$) should be within the limits specified. Outside of these ranges, the converter's linearity may not meet specifications. To minimize noise, low bandwidth input signals with low-pass filters should be used.

Care should be taken to ensure that the output impedance of the sources driving the +IN and –IN inputs are matched. If this is not observed, the two inputs could have different settling times. This may result in offset error, gain error, and linearity error which varies with temperature and input voltage. A typical input circuit using TI's THS4031 is shown in Figure 33.

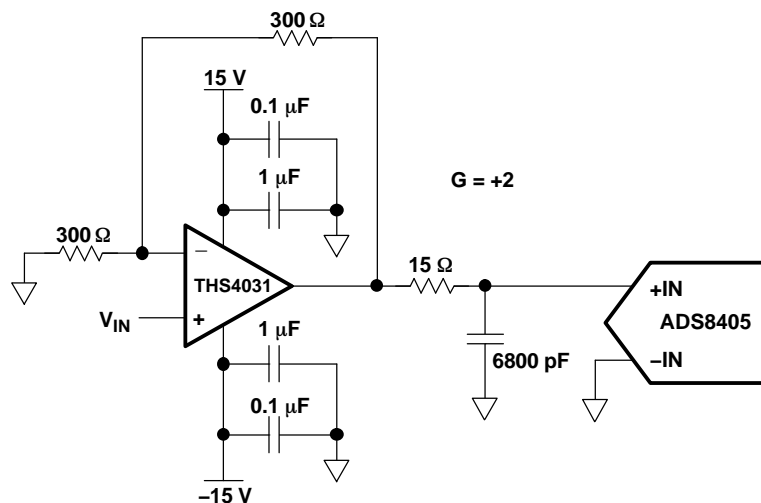

Figure 33. Using the THS4031 with the ADS8405

PRINCIPLES OF OPERATION (continued)
DIGITAL INTERFACE

Timing And Control

See the timing diagrams in the specifications section for detailed information on timing signals and their requirements.

The ADS8405 uses an internal oscillator generated clock which controls the conversion rate and in turn the throughput of the converter. No external clock input is required.

Conversions are initiated by bringing the $\overline{\text{CONVST}}$ pin low for a minimum of 20 ns (after the 20 ns minimum requirement has been met, the $\overline{\text{CONVST}}$ pin can be brought high) while $\overline{\text{CS}}$ is low. The ADS8405 switches from the sample to the hold mode on the falling edge of the $\overline{\text{CONVST}}$ command. A clean and low jitter falling edge of this signal is important to the performance of the converter. The BUSY output is brought high after $\overline{\text{CONVST}}$ goes low. BUSY stays high throughout the conversion process and returns low when the conversion has ended.

Sampling starts as soon as the conversion is over when $\overline{\text{CS}}$ is tied low or starts with the falling edge of $\overline{\text{CS}}$ when BUSY is low.

Both $\overline{\text{RD}}$ and $\overline{\text{CS}}$ can be high during and before a conversion with one exception ($\overline{\text{CS}}$ must be low when $\overline{\text{CONVST}}$ goes low to initiate a conversion). Both the $\overline{\text{RD}}$ and $\overline{\text{CS}}$ pins are brought low in order to enable the parallel output bus with the conversion.

Reading Data

The ADS8405 outputs full parallel data in straight binary format as shown in Table 1. The parallel output is active when $\overline{\text{CS}}$ and $\overline{\text{RD}}$ are both low. There is a minimal quiet zone requirement around the falling edge of $\overline{\text{CONVST}}$. This is 50 ns prior to the falling edge of $\overline{\text{CONVST}}$ and 40 ns after the falling edge. No data read should be attempted within this zone. Any other combination of $\overline{\text{CS}}$ and $\overline{\text{RD}}$ sets the parallel output to 3-state. BYTE is used for multiword read operations. BYTE is used whenever lower bits of the converter result are output on the higher byte of the bus. Refer to Table 1 for ideal output codes.

Table 1. Ideal Input Voltages and Output Codes

| DESCRIPTION | ANALOG VALUE | DIGITAL OUTPUT | |
|-----------------------------|---------------------------------------|---------------------|-----------------|
| | | STRAIGHT BINARY | |
| Full scale range | $+V_{\text{ref}}$ | | |
| Least significant bit (LSB) | $(+V_{\text{ref}})/65536$ | BINARY CODE | HEX CODE |
| Full scale | $(+V_{\text{ref}}) - 1 \text{ LSB}$ | 1111 1111 1111 1111 | FFFF |
| Midscale | $(+V_{\text{ref}})/2$ | 1000 0000 0000 0000 | 8000 |
| Midscale – 1 LSB | $(+V_{\text{ref}})/2 - 1 \text{ LSB}$ | 0111 1111 1111 1111 | 7FFF |
| Zero | 0 V | 0000 0000 0000 0000 | 0000 |

The output data is a full 16-bit word (D15 – D0) on the DB15 – DB0 pins (MSB-LSB) if BYTE is low.

The result may also be read on an 8-bit bus for convenience. This is done by using only pins DB15 – DB8. In this case two reads are necessary: the first as before, leaving BYTE low and reading the 8 most significant bits on pins DB15 – DB8, then bringing BYTE high. When BYTE is high, the low bits (D7 – D0) appear on pins DB15 – D8.

These multiword read operations can be done with multiple active $\overline{\text{RD}}$ (toggling) or with $\overline{\text{RD}}$ tied low for simplicity.

Conversion Data Readout

| BYTE | DATA READ OUT | |
|------|---------------|--------------|
| | DB15–DB8 Pins | DB7–DB0 Pins |
| High | D7–D0 | All one's |
| Low | D15–D8 | D7–D0 |

RESET

$\overline{\text{RESET}}$ is an asynchronous active low input signal (that works independently of $\overline{\text{CS}}$). Minimum $\overline{\text{RESET}}$ low time is 25 ns. The current conversion is aborted no later than 50 ns after the converter is in reset mode. In addition, all output latches are cleared (set to zero's) after $\overline{\text{RESET}}$. The converter goes back to normal operation mode no later than 20 ns after the $\overline{\text{RESET}}$ input is brought high.

The converter starts the first sampling period 20 ns after the rising edge of $\overline{\text{RESET}}$. Any sampling period except for the one immediately after a $\overline{\text{RESET}}$ is started with the falling edge of the previous BUSY signal or the falling edge of CS, whichever is later.

Another way to reset the device is through the use of the combination of $\overline{\text{CS}}$ and $\overline{\text{CONVST}}$. This is useful when the dedicated $\overline{\text{RESET}}$ pin is tied to the system reset but there is a need to abort only the conversion in a specific converter. Since the BUSY signal is held high during the conversion, either one of these conditions triggers an internal self-clear reset to the converter just the same as a reset via the dedicated $\overline{\text{RESET}}$ pin. The reset does not have to be cleared as for the dedicated $\overline{\text{RESET}}$ pin. A reset can be started with either of the two following steps.

- Issue a $\overline{\text{CONVST}}$ when $\overline{\text{CS}}$ is low and a conversion is in progress. The falling edge of $\overline{\text{CONVST}}$ must satisfy the timing as specified by the timing parameter $t_{\text{su(AB)}}$ specified in the timing characteristics table to ensure a reset. The falling edge of $\overline{\text{CONVST}}$ starts a reset. The timing is the same as a reset using the dedicated $\overline{\text{RESET}}$ pin except the instance of the falling edge is replaced by the falling edge of $\overline{\text{CONVST}}$.
- Issue a $\overline{\text{CS}}$ while a conversion is in progress. The falling edge of $\overline{\text{CS}}$ must satisfy the timing as specified by the timing parameter $t_{\text{su(AB)}}$ specified in the timing characteristics table to ensure a reset. The falling edge of $\overline{\text{CS}}$ causes a reset. The timing is the same as a reset using the dedicated $\overline{\text{RESET}}$ pin except the instance of the falling edge is replaced by the falling edge of $\overline{\text{CS}}$.

POWER-ON INITIALIZATION

RESET is not required after power on. An internal power-on reset circuit generates the reset. To ensure that all of the registers are cleared, the three conversion cycles must be given to the converter after power on.

LAYOUT

For optimum performance, care should be taken with the physical layout of the ADS8405 circuitry.

As the ADS8405 offers single-supply operation, it is often used in close proximity with digital logic, microcontrollers, microprocessors, and digital signal processors. The more digital logic present in the design and the higher the switching speed, the more difficult it is to achieve good performance from the converter.

The basic SAR architecture is sensitive to glitches or sudden changes on the power supply, reference, ground connections, and digital inputs that occur just prior to latching the output of the analog comparator. Thus, driving any single conversion for an n-bit SAR converter, there are at least n *windows* in which large external transient voltages can affect the conversion result. Such glitches might originate from switching power supplies, nearby digital logic, or high power devices.

The degree of error in the digital output depends on the reference voltage, layout, and the exact timing of the external event.

On average, the ADS8405 draws very little current from an external reference, as the reference voltage is internally buffered. If the reference voltage is external and originates from an op amp, make sure that it can drive the bypass capacitor or capacitors without oscillation. A 0.1- μF bypass capacitor and a 1- μF storage capacitor are recommended from pin 1 (REFIN) directly to pin 48 (REFM). REFM and AGND should be shorted on the same ground plane under the device.

The AGND and BDGND pins should be connected to a clean ground point. In all cases, this should be the analog ground. Avoid connections which are close to the grounding point of a microcontroller or digital signal processor. If required, run a ground trace directly from the converter to the power supply entry point. The ideal layout consists of an analog ground plane dedicated to the converter and associated analog circuitry.

As with the AGND connections, +VA should be connected to a 5-V power supply plane or trace that is separate from the connection for digital logic until they are connected at the power entry point. Power to the ADS8405 should be clean and well bypassed. A 0.1- μ F ceramic bypass capacitor should be placed as close to the device as possible. See Table 2 for the placement of the capacitor. In addition, a 1- μ F to 10- μ F capacitor is recommended. In some situations, additional bypassing may be required, such as a 100- μ F electrolytic capacitor or even a Pi filter made up of inductors and capacitors—all designed to essentially low-pass filter the 5-V supply, removing the high frequency noise.

Table 2. Power Supply Decoupling Capacitor Placement

| POWER SUPPLY PLANE SUPPLY PINS | CONVERTER ANALOG SIDE | CONVERTER DIGITAL SIDE |
|---|---|------------------------|
| Pin pairs that require shortest path to decoupling capacitors | (4,5), (8,9), (10,11), (13,15), (43,44), (45,46) | (24,25), (34, 35) |
| Pins that require no decoupling | 12, 14 | 37 |

PACKAGING INFORMATION

| Orderable Device | Status ⁽¹⁾ | Package Type | Package Drawing | Pins | Package Qty | Eco Plan ⁽²⁾ | Lead/Ball Finish | MSL Peak Temp ⁽³⁾ |
|------------------|-----------------------|--------------|-----------------|------|-------------|-------------------------|------------------|------------------------------|
| ADS8405IBPFBR | ACTIVE | TQFP | PFB | 48 | 1000 | Green (RoHS & no Sb/Br) | CU NIPDAU | Level-2-260C-1 YEAR |
| ADS8405IBPFBRG4 | ACTIVE | TQFP | PFB | 48 | 1000 | Green (RoHS & no Sb/Br) | CU NIPDAU | Level-2-260C-1 YEAR |
| ADS8405IBPFBT | ACTIVE | TQFP | PFB | 48 | 250 | Green (RoHS & no Sb/Br) | CU NIPDAU | Level-2-260C-1 YEAR |
| ADS8405IBPFBTG4 | ACTIVE | TQFP | PFB | 48 | 250 | Green (RoHS & no Sb/Br) | CU NIPDAU | Level-2-260C-1 YEAR |
| ADS8405IPFBR | ACTIVE | TQFP | PFB | 48 | 1000 | Green (RoHS & no Sb/Br) | CU NIPDAU | Level-2-260C-1 YEAR |
| ADS8405IPFBRG4 | ACTIVE | TQFP | PFB | 48 | 1000 | Green (RoHS & no Sb/Br) | CU NIPDAU | Level-2-260C-1 YEAR |
| ADS8405IPFBT | ACTIVE | TQFP | PFB | 48 | 250 | Green (RoHS & no Sb/Br) | CU NIPDAU | Level-2-260C-1 YEAR |
| ADS8405IPFBTG4 | ACTIVE | TQFP | PFB | 48 | 250 | Green (RoHS & no Sb/Br) | CU NIPDAU | Level-2-260C-1 YEAR |

⁽¹⁾ The marketing status values are defined as follows:

ACTIVE: Product device recommended for new designs.

LIFEBUY: TI has announced that the device will be discontinued, and a lifetime-buy period is in effect.

NRND: Not recommended for new designs. Device is in production to support existing customers, but TI does not recommend using this part in a new design.

PREVIEW: Device has been announced but is not in production. Samples may or may not be available.

OBSOLETE: TI has discontinued the production of the device.

⁽²⁾ Eco Plan - The planned eco-friendly classification: Pb-Free (RoHS), Pb-Free (RoHS Exempt), or Green (RoHS & no Sb/Br) - please check <http://www.ti.com/productcontent> for the latest availability information and additional product content details.

TBD: The Pb-Free/Green conversion plan has not been defined.

Pb-Free (RoHS): TI's terms "Lead-Free" or "Pb-Free" mean semiconductor products that are compatible with the current RoHS requirements for all 6 substances, including the requirement that lead not exceed 0.1% by weight in homogeneous materials. Where designed to be soldered at high temperatures, TI Pb-Free products are suitable for use in specified lead-free processes.

Pb-Free (RoHS Exempt): This component has a RoHS exemption for either 1) lead-based flip-chip solder bumps used between the die and package, or 2) lead-based die adhesive used between the die and leadframe. The component is otherwise considered Pb-Free (RoHS compatible) as defined above.

Green (RoHS & no Sb/Br): TI defines "Green" to mean Pb-Free (RoHS compatible), and free of Bromine (Br) and Antimony (Sb) based flame retardants (Br or Sb do not exceed 0.1% by weight in homogeneous material)

⁽³⁾ MSL, Peak Temp. -- The Moisture Sensitivity Level rating according to the JEDEC industry standard classifications, and peak solder temperature.

Important Information and Disclaimer:The information provided on this page represents TI's knowledge and belief as of the date that it is provided. TI bases its knowledge and belief on information provided by third parties, and makes no representation or warranty as to the accuracy of such information. Efforts are underway to better integrate information from third parties. TI has taken and continues to take reasonable steps to provide representative and accurate information but may not have conducted destructive testing or chemical analysis on incoming materials and chemicals. TI and TI suppliers consider certain information to be proprietary, and thus CAS numbers and other limited information may not be available for release.

In no event shall TI's liability arising out of such information exceed the total purchase price of the TI part(s) at issue in this document sold by TI to Customer on an annual basis.

TAPE AND REEL INFORMATION



QUADRANT ASSIGNMENTS FOR PIN 1 ORIENTATION IN TAPE



*All dimensions are nominal

| Device | Package Type | Package Drawing | Pins | SPQ | Reel Diameter (mm) | Reel Width W1 (mm) | A0 (mm) | B0 (mm) | K0 (mm) | P1 (mm) | W (mm) | Pin1 Quadrant |
|---------------|--------------|-----------------|------|------|--------------------|--------------------|---------|---------|---------|---------|--------|---------------|
| ADS8405IBPFBR | TQFP | PFB | 48 | 1000 | 330.0 | 16.4 | 9.6 | 9.6 | 1.5 | 12.0 | 16.0 | Q2 |
| ADS8405IBPFBT | TQFP | PFB | 48 | 250 | 330.0 | 16.4 | 9.6 | 9.6 | 1.5 | 12.0 | 16.0 | Q2 |
| ADS8405IPFBR | TQFP | PFB | 48 | 1000 | 330.0 | 16.4 | 9.6 | 9.6 | 1.5 | 12.0 | 16.0 | Q2 |
| ADS8405IPFBT | TQFP | PFB | 48 | 250 | 330.0 | 16.4 | 9.6 | 9.6 | 1.5 | 12.0 | 16.0 | Q2 |

TAPE AND REEL BOX DIMENSIONS



*All dimensions are nominal

| Device | Package Type | Package Drawing | Pins | SPQ | Length (mm) | Width (mm) | Height (mm) |
|---------------|--------------|-----------------|------|------|-------------|------------|-------------|
| ADS8405IBPFBR | TQFP | PFB | 48 | 1000 | 346.0 | 346.0 | 33.0 |
| ADS8405IBPFBT | TQFP | PFB | 48 | 250 | 346.0 | 346.0 | 33.0 |
| ADS8405IPFBR | TQFP | PFB | 48 | 1000 | 346.0 | 346.0 | 33.0 |
| ADS8405IPFBT | TQFP | PFB | 48 | 250 | 346.0 | 346.0 | 33.0 |

PFB (S-PQFP-G48)

PLASTIC QUAD FLATPACK

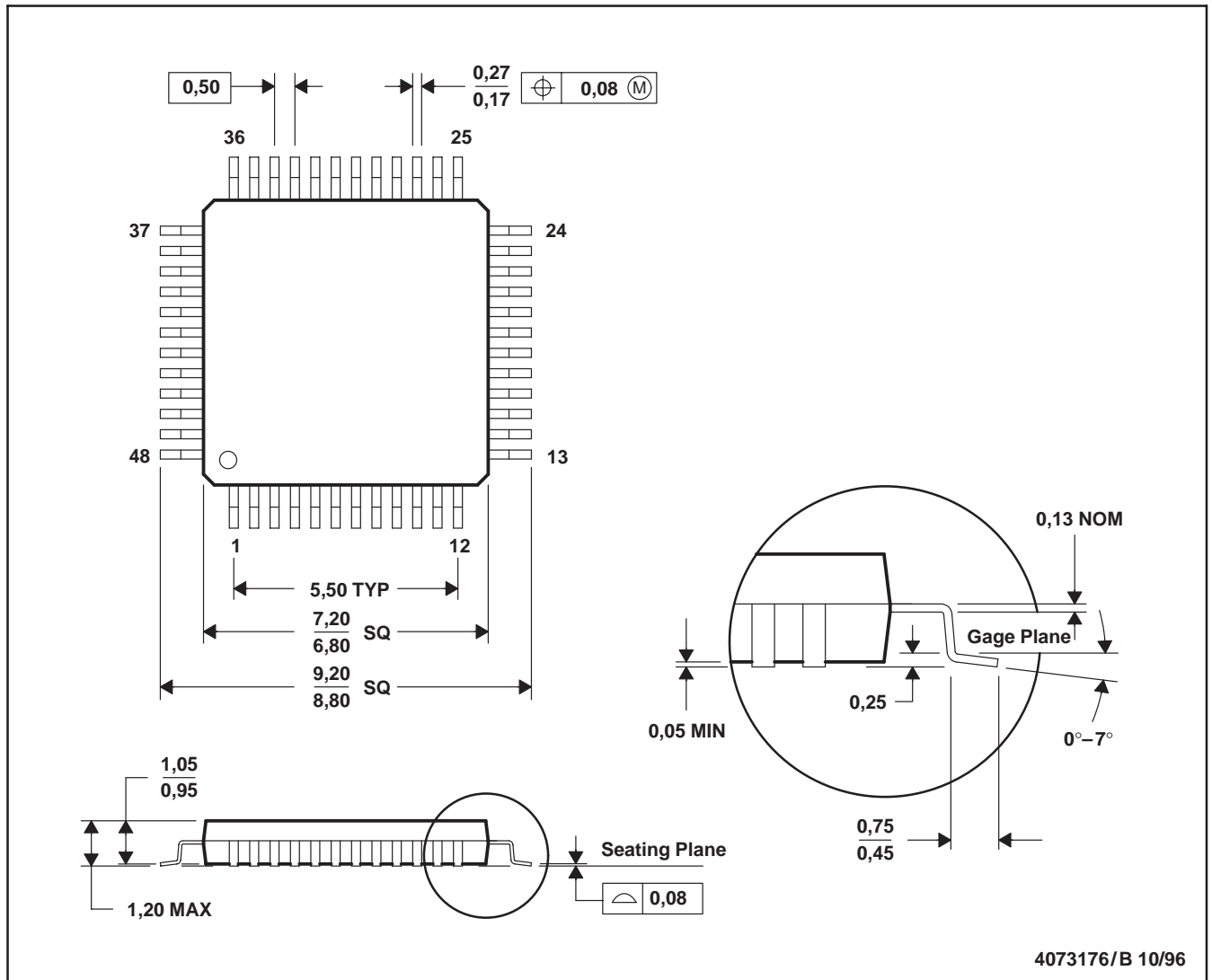

- NOTES: A. All linear dimensions are in millimeters.
 B. This drawing is subject to change without notice.
 C. Falls within JEDEC MS-026

PFB (S-PQFP-G48)



- NOTES:
- A. All linear dimensions are in millimeters.
 - B. This drawing is subject to change without notice.
 - C. Publication IPC-7351 is recommended for alternate designs.
 - D. Laser cutting apertures with trapezoidal walls and also rounding corners will offer better paste release. Customers should contact their board assembly site for stencil design recommendations. Refer to IPC-7525.
 - E. Customers should contact their board fabrication site for solder mask tolerances between and around signal pads.

IMPORTANT NOTICE

Texas Instruments Incorporated and its subsidiaries (TI) reserve the right to make corrections, modifications, enhancements, improvements, and other changes to its products and services at any time and to discontinue any product or service without notice. Customers should obtain the latest relevant information before placing orders and should verify that such information is current and complete. All products are sold subject to TI's terms and conditions of sale supplied at the time of order acknowledgment.

TI warrants performance of its hardware products to the specifications applicable at the time of sale in accordance with TI's standard warranty. Testing and other quality control techniques are used to the extent TI deems necessary to support this warranty. Except where mandated by government requirements, testing of all parameters of each product is not necessarily performed.

TI assumes no liability for applications assistance or customer product design. Customers are responsible for their products and applications using TI components. To minimize the risks associated with customer products and applications, customers should provide adequate design and operating safeguards.

TI does not warrant or represent that any license, either express or implied, is granted under any TI patent right, copyright, mask work right, or other TI intellectual property right relating to any combination, machine, or process in which TI products or services are used. Information published by TI regarding third-party products or services does not constitute a license from TI to use such products or services or a warranty or endorsement thereof. Use of such information may require a license from a third party under the patents or other intellectual property of the third party, or a license from TI under the patents or other intellectual property of TI.

Reproduction of TI information in TI data books or data sheets is permissible only if reproduction is without alteration and is accompanied by all associated warranties, conditions, limitations, and notices. Reproduction of this information with alteration is an unfair and deceptive business practice. TI is not responsible or liable for such altered documentation. Information of third parties may be subject to additional restrictions.

Resale of TI products or services with statements different from or beyond the parameters stated by TI for that product or service voids all express and any implied warranties for the associated TI product or service and is an unfair and deceptive business practice. TI is not responsible or liable for any such statements.

TI products are not authorized for use in safety-critical applications (such as life support) where a failure of the TI product would reasonably be expected to cause severe personal injury or death, unless officers of the parties have executed an agreement specifically governing such use. Buyers represent that they have all necessary expertise in the safety and regulatory ramifications of their applications, and acknowledge and agree that they are solely responsible for all legal, regulatory and safety-related requirements concerning their products and any use of TI products in such safety-critical applications, notwithstanding any applications-related information or support that may be provided by TI. Further, Buyers must fully indemnify TI and its representatives against any damages arising out of the use of TI products in such safety-critical applications.

TI products are neither designed nor intended for use in military/aerospace applications or environments unless the TI products are specifically designated by TI as military-grade or "enhanced plastic." Only products designated by TI as military-grade meet military specifications. Buyers acknowledge and agree that any such use of TI products which TI has not designated as military-grade is solely at the Buyer's risk, and that they are solely responsible for compliance with all legal and regulatory requirements in connection with such use.

TI products are neither designed nor intended for use in automotive applications or environments unless the specific TI products are designated by TI as compliant with ISO/TS 16949 requirements. Buyers acknowledge and agree that, if they use any non-designated products in automotive applications, TI will not be responsible for any failure to meet such requirements.

Following are URLs where you can obtain information on other Texas Instruments products and application solutions:

Products

| | |
|-----------------------------|--|
| Amplifiers | amplifier.ti.com |
| Data Converters | dataconverter.ti.com |
| DSP | dsp.ti.com |
| Clocks and Timers | www.ti.com/clocks |
| Interface | interface.ti.com |
| Logic | logic.ti.com |
| Power Mgmt | power.ti.com |
| Microcontrollers | microcontroller.ti.com |
| RFID | www.ti-rfid.com |
| RF/IF and ZigBee® Solutions | www.ti.com/lprf |

Applications

| | |
|--------------------|--|
| Audio | www.ti.com/audio |
| Automotive | www.ti.com/automotive |
| Broadband | www.ti.com/broadband |
| Digital Control | www.ti.com/digitalcontrol |
| Medical | www.ti.com/medical |
| Military | www.ti.com/military |
| Optical Networking | www.ti.com/opticalnetwork |
| Security | www.ti.com/security |
| Telephony | www.ti.com/telephony |
| Video & Imaging | www.ti.com/video |
| Wireless | www.ti.com/wireless |

Mailing Address: Texas Instruments, Post Office Box 655303, Dallas, Texas 75265
Copyright © 2008, Texas Instruments Incorporated